

# balak

## ficha técnica

### datasheet

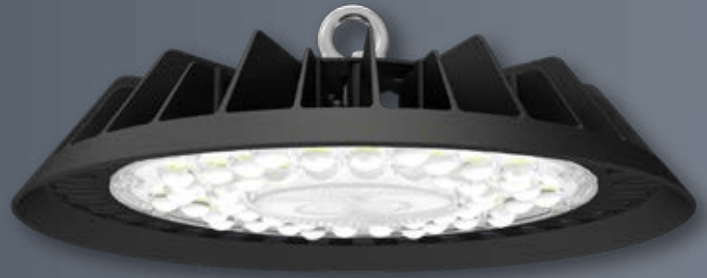

ref.5551393

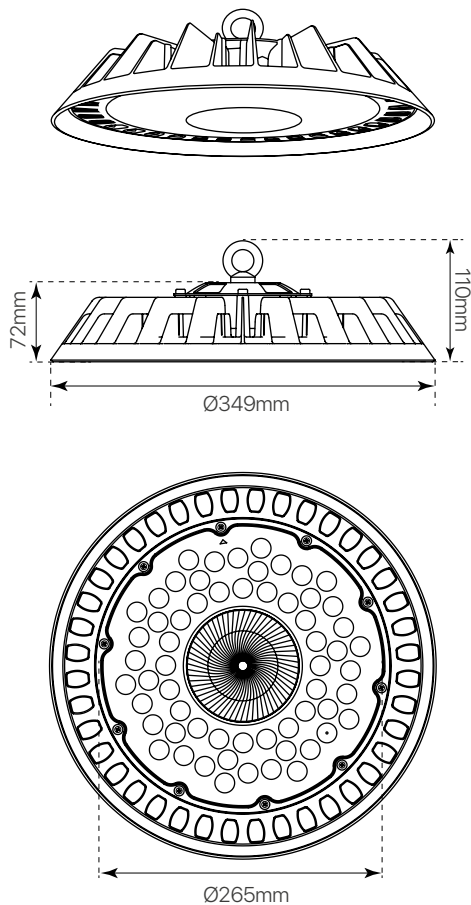

Nombre / Name	Balak, campana led 200W
Referencia / Reference	5551393
Materiales / Materials	Aluminio+PC
Difusor / Diffuser	PC
Potencia / Power	200W
Temperatura de color / color temperature	4000K
Flujo luminoso / Lumens	21700lm
Dimable / Dimmable	No
Ángulo de apertura / Beam angle	90°
Ángulo de inclinación / Inclination angle	-
IP	IP65
IK	08
F.P. / P.F.	>0,9
UGR	-
IRC / CRI	>70
Chip	PHILIPS Lumileds 2835
Driver	i-TEC series
Vida media (duración) / Average life	+30.000h
Clase energética / Energy class	A+
Aislamiento eléctrico / Electrical isolation	Clase I
Colores / Colors	Negro / Black
Medida exterior / Product size	Ø349mm x 72mm
Protección contra Sobretensiones / Surge protection	2kV
Tª (ambiente/trabajo) / Tª (environment/work)	-40°C ~ +50°C
Input	AC220 ~ 240V
Output	DC220V
Frecuencia / Frequency	50/60Hz
Peso / Weight	2,24kg
Certificados / Certificates	CE, RoHS
Garantía / Warranty	2 años/ 2 years